

### MODEL No's: HVLP731, HVLP741.V2, HVLP742

Thank you for purchasing a Sealey product. Manufactured to a high standard this product will, if used according to these instructions and properly maintained, give you years of trouble free performance.



**IMPORTANT: PLEASE READ THESE INSTRUCTIONS CAREFULLY. NOTE THE SAFE OPERATIONAL REQUIREMENTS, WARNINGS AND CAUTIONS. USE THIS PRODUCT CORRECTLY AND WITH CARE FOR THE PURPOSE FOR WHICH IT IS INTENDED. FAILURE TO DO SO MAY CAUSE DAMAGE AND/OR PERSONAL INJURY AND WILL INVALIDATE THE WARRANTY. PLEASE KEEP INSTRUCTIONS SAFE FOR FUTURE USE.**

#### 1. SAFETY INSTRUCTIONS

- ✓ Familiarise yourself with the application, limitations and potential hazards peculiar to the spray gun.
- ❑ **WARNING!** Disconnect the spray gun from the air supply before changing accessories, servicing or performing any maintenance.
- ✓ Maintain the spray gun in good condition (use an authorised service agent).
- ✓ Replace or repair damaged parts. *Use authorised parts only. Unauthorised parts may be dangerous and will invalidate the warranty.*
- ✓ Keep the spray gun clean for best and safest performance.
- ✓ Ensure that the compressed air system can supply the spray gun air consumption for the model to be used.
- ✓ Wear approved safety respiratory protection and safety eye goggles.
- ✓ If spraying isocyanate based finisher, wear approved respirator/clean air breathing apparatus and cover exposed skin with latex gloves and an impervious hooded coverall.
- ✓ Remove ill-fitting clothing. Remove ties, watches, rings and other loose jewellery and tie back long hair.
- ✓ Locate the spray gun in a suitable work area. Keep area clean and tidy and free from unrelated materials and ensure that there is adequate ventilation and lighting.
- ✓ Keep children and unauthorised persons away from the work area.
- ✓ When not in use, ensure that the air supply is turned off.
- ✓ Avoid unintentional operation of spray gun.
- ✓ The spray gun has been treated with an anticorrosive agent at the factory and **MUST** be flushed out thoroughly with thinner before use.
- x DO NOT point spray gun at yourself, other persons or animals.
- x DO NOT direct air from the air hose at yourself, other persons or animals.
- x DO NOT carry the spray gun by the hose, or yank the hose from the air supply.
- x DO NOT exceed the working pressure of 43psi (3bar).
- x DO NOT use the spray gun for any purpose other than that for which it is designed.
- x DO NOT allow untrained persons to operate the spray gun.
- x DO NOT get the spray gun wet or use in damp or wet locations or in areas where there is condensation.
- x DO NOT operate the spray gun if any parts are missing or damaged as this may cause failure and/or personal injury.
- ✓ When not in use, disconnect the spray gun from the air supply, clean thoroughly and store safely.

#### 2. INTRODUCTION AND SPECIFICATIONS

**HVLP741.V2 / HVLP742 Gravity Feed Spray Guns**  
Round/flat fan control allows the spray pattern to be adjusted for any job. Anodized spray gun body resists corrosion and makes for easier cleaning.

The HVLP741.V2 Gravity Feed Spray Gun has a brass air cap with stainless steel needle and nozzle make it suitable for waterborne paint. Supplied with a 1.3 set-up suitable for topcoats. Other set-ups are available separately as shown below.

The HVLP742 Gravity Feed Spray Gun has an aluminium air cap with stainless steel needle and nozzle make it suitable for waterborne paint. Supplied with 2.0mm set-up suitable for primer. Other set-ups are available separately as shown below.

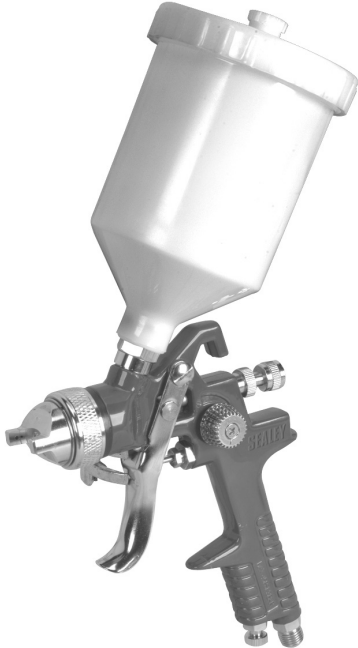

<b>Model No:</b> .....	<b>HVLP741.V2</b> .....	<b>HVLP742</b>
Supplied standard set-up: .....	1.3mm.....	2.0mm
Available set-ups: .....	1.2, 1.4, 1.7, 2.0mm.....	1.4, 1.7mm
Working pressure: .....	43psi (3bar).....	43psi (3bar)
Air consumption:.....	15.0cfm (425 l/min)....	15.0cfm (425 l/min)
Pot capacity.....	.600ml.....	.600ml

**HVLP731 Gravity Feed Touch Up Spray Gun**  
Ideal for blowing-in small areas of panel where fine control of paint and air is necessary. Anodized spray gun body resists corrosion and makes for easier cleaning. Brass air cap with stainless steel needle and nozzle make it suitable for waterborne paint. Supplied with 0.8mm set-up, 1.0mm set-up is available separately.



<b>Model No:</b> .....	<b>HVLP731</b>
Supplied standard set-up: .....	0.8mm
Available set-ups: .....	1.0mm
Working pressure: .....	43psi (3bar)
Air consumption:.....	9.0cfm (255 l/min)
Pot capacity.....	100ml

### 3. AIR SUPPLY

#### 3.1. Air Supply

Recommended hook-up is shown in Fig.1.

- 3.1.1. Ensure spray gun air valve (or trigger) is in the off position before connecting to the air supply.
- 3.1.2. You will require an air pressure of 43psi, and an air flow according to specification.
- 3.1.3.  **WARNING!** Ensure the air supply is clean and does not exceed 43psi while operating the spray gun. Too high an air pressure and/or unclean air will shorten the product life due to excessive wear, and may be dangerous causing damage and/or personal injury.
- 3.1.4. Drain the air tank daily. Water in the air line will ruin the paint finish and damage the spray gun.
- 3.1.5. Clean air inlet filter weekly.
- 3.1.6. Line pressure should be increased to compensate for unusually long air hoses (over 8 metres). The minimum hose diameter should be 1/4" I.D. and fittings must have the same inside dimensions.
- 3.1.7. Keep hose away from heat, oil and sharp edges. Check hose for wear, and make certain that all connections are secure.

#### 3.2. Couplings

Vibration may cause failure if a quick change coupling is connected directly to the spray gun. To overcome this, connect a leader hose to the spray gun. A quick change coupling may then be used to connect the leader hose to the air line recoil hose (Figs.1 and 2).

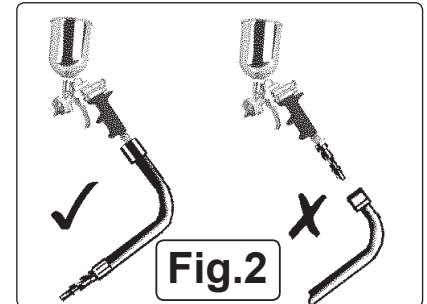
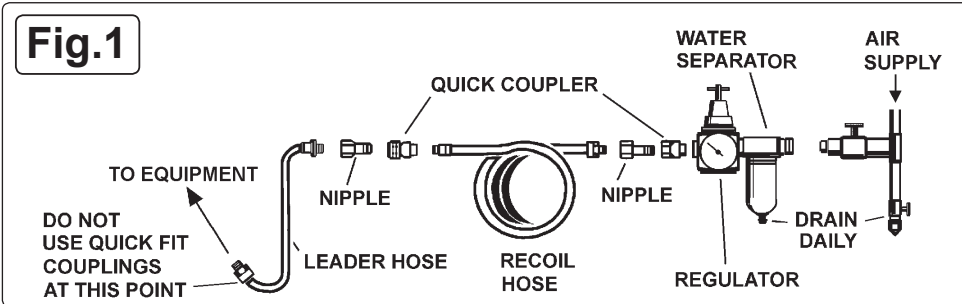

### 4. INSTRUCTIONS

- 4.1. For best results, the gun should be held perpendicular to the surface being sprayed and moved parallel to it. Start the stroke before squeezing the trigger and release the trigger before finishing the stroke. This will enable accurate control of the gun and material (Fig.3B).
- 4.2. Spray from a distance of about 6 to 10 inches (150 to 250mm) depending on the material and the atomizing pressure. The material deposited should always be even and wet. Each stroke must overlap the preceding stroke to obtain a uniform finish. To reduce over-spray and obtain maximum efficiency, spray with the lowest possible atomizing air pressure.
- 4.3. Controlling the fan spray and the fluid.
  - a) Use the needle (paint) adjustment knob (Fig.4.2) to adjust the amount of paint flow.
  - b) The atomizing air flow is controlled by the control knob (Fig.4.1).
  - c) The volume of air input is controlled by the adjustment knob (Fig.4.3).
  - d) As width of spray is increased more material must pass through the gun to obtain the same coverage on the increased area.
  - e) Turn the air nozzle (Fig.4.4) to achieve a horizontal or vertical fan spray. Lock the nozzle with retaining ring (Fig.4.5).

The spray pattern of the gun is variable from round to flat with all patterns in between. In normal operation, the wings on the nozzle are horizontal (Fig.5). This provides a vertical fan-shaped pattern which gives maximum, uniform and even coverage when moving the gun back and forth, parallel to the work surface (Fig.6).

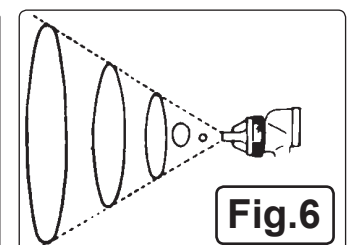
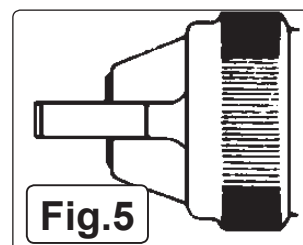
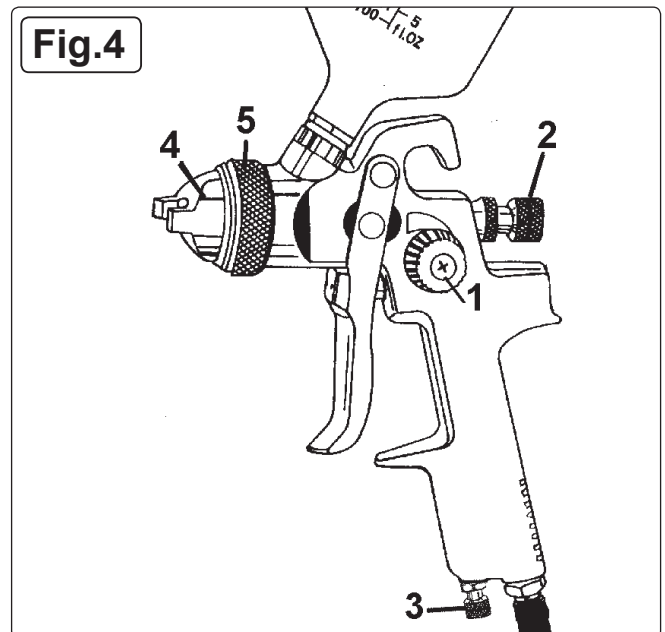
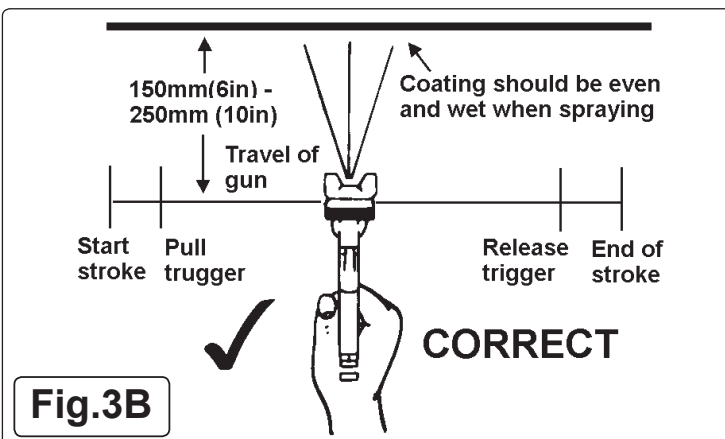
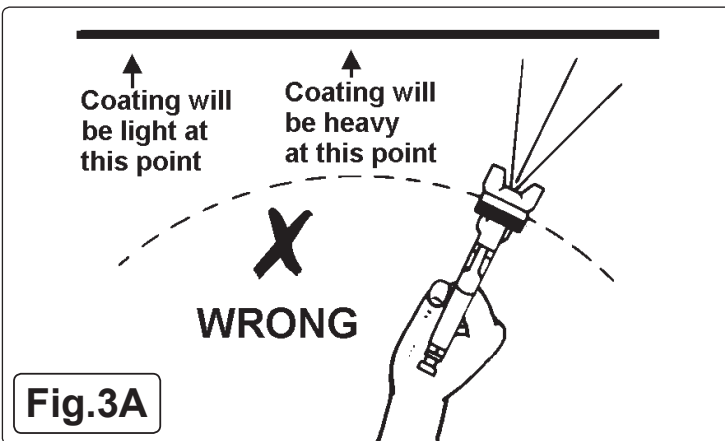

## 5. CLEANING AND MAINTENANCE

FOR OPTIMUM PERFORMANCE IT IS VERY IMPORTANT TO ENSURE THE SPRAY GUN IS CORRECTLY CLEANED AFTER EACH USE.

Disconnect from the air supply before attempting any cleaning or maintenance.

### 5.1. Cleaning the gun



- 5.1.1. Flush the gun through with clean solvent.
- 5.1.2. Use a bristle brush and solvent to wash off accumulated paint.
- 5.1.3. Clean the air nozzle using a brush. Blow clean with air. Handle all nozzles carefully and do not make any alterations in the gun.
- 5.1.4. Wipe the outside of the gun with a dampened solvent rag.
- 5.1.5. If there is a need to probe the holes in the nozzles, ensure a tool that is softer than brass is utilised, under no circumstances use a metal tool, as the slightest amount of damage will adversely affect the spray pattern.
- 5.1.6. Adjust the fluid needle valve so that when the gun is triggered, air flow occurs before fluid flow.

### 5.2. Maintenance

- Take care when re-assembling. Screw parts hand tight to avoid cross-threading. If a part cannot easily be turned by hand, check that it is the correct part, or unscrew it, realign and retry. **DO NOT** use excessive force when re-assembling.
- 5.2.1. When changing the nozzle size, ensure the complete nozzle set is fitted. This consists of air cap, fluid nozzle and paint needle. Insert the fluid nozzle before paint needle.

## 6. PROBLEM SOLVING

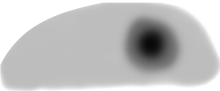
A faulty spray is usually caused by improper cleaning or dried material around the fluid nozzle tip or in the air nozzle. If cleaning is required, remove these parts and soak them in solvent. This will soften the dried material which can then be removed with a brush or a cloth. These parts are carefully machined and any damage to them will cause a faulty spray. If either the air nozzle or fluid nozzle are damaged, they must be replaced before a perfect spray can be obtained.





PROBLEM	POSSIBLE CAUSES	SOLUTION
	Dried material in a side port restricts passage of air. Greater flow of air from the clean side port forces a fan pattern in the direction of the clogged side.	Dissolve material in the side ports with solvent, then blow the gun clean. Do not poke into the nozzles with metal instruments.
	Dried material around the outside of the fluid nozzle tip restricts the passage of atomizing air at one point through the centre opening of the air nozzle and results in the pattern shown. This pattern can also be caused by a loose air nozzle.	Remove the air nozzle and wipe off fluid tip using a rag dampened with solvent. Tighten the air nozzle.
	Material too thin or atomization air pressure too high.	Regulate material viscosity or reduce air pressure.
 Paint spray 'flutters'	Not enough paint in bottle. Nozzle set / seating dirty, damaged or loosely installed.	Refill bottle. Remove the fluid nozzle, clean the back of the nozzle and the nozzle seat using a cloth dampened with thinner. Refit the nozzle and secure it tightly against the body. If necessary replace nozzle set.
Material bubbles or "boils" in paint cup.	Atomised air flowing through the paint channel to the bottle. The paint nozzle is not sufficiently tight. Air nozzle is not completely screwed on.	Tighten, clean or replace parts accordingly.

**NOTE:** It is our policy to continually improve products and as such we reserve the right to alter data, specifications and component parts without prior notice.

**IMPORTANT:** No liability is accepted for incorrect use of this product.

**WARRANTY:** Guarantee is 12 months from purchase date, proof of which will be required for any claim.

**INFORMATION:** For a copy of our latest catalogue and promotions call us on 01284 757525 and leave your full name and address, including postcode.

	<b>Sole UK Distributor, Sealey Group,</b> Kempson Way, Suffolk Business Park, Bury St. Edmunds, Suffolk, IP32 7AR	 01284 757500	 <a href="http://www.sealey.co.uk">www.sealey.co.uk</a>
		 01284 703534	 <a href="mailto:sales@sealey.co.uk">sales@sealey.co.uk</a>