

Thank you for purchasing a Sealey product. Manufactured to a high standard this product will, if used according to these instructions and properly maintained, give you years of trouble free performance.



IMPORTANT: PLEASE READ THESE INSTRUCTIONS CAREFULLY. NOTE THE SAFE OPERATIONAL REQUIREMENTS, WARNINGS AND CAUTIONS. USE THIS PRODUCT CORRECTLY AND WITH CARE FOR THE PURPOSE FOR WHICH IT IS INTENDED. FAILURE TO DO SO MAY CAUSE DAMAGE AND/OR PERSONAL INJURY AND WILL INVALIDATE THE WARRANTY. PLEASE KEEP INSTRUCTIONS SAFE FOR FUTURE USE.

1. SAFETY INSTRUCTIONS

1.1. ELECTRICAL SAFETY

WARNING! It is the responsibility of the owner and the operator to read, understand and comply with the following:

You must check all electrical products, before use, to ensure that they are safe. You must inspect power cables, plugs, sockets and any other connectors for wear or damage. You must ensure that the risk of electric shock is minimised by the installation of appropriate safety devices. A Residual Current Circuit Breaker (RCCB) should be incorporated in the main distribution board. We also recommend that a Residual Current Device (RCD) is used. It is particularly important to use an RCD with portable products that are plugged into a supply which is not protected by an RCCB. If in any doubt consult a qualified electrician. You may obtain a Residual Current Device by contacting your Sealey dealer. **You must** also read and understand the following instructions concerning electrical safety.

- 1.1.1. The **Electricity at Work Act 1989** requires all portable electrical appliances, if used on business premises, to be tested by a qualified electrician, using a Portable Appliance Tester (PAT), at least once a year.
- 1.1.2. The **Health & Safety at Work Act 1974** makes owners of electrical appliances responsible for the safe condition of those appliances and the safety of the appliance operators. **If in any doubt about electrical safety, contact a qualified electrician.**
- 1.1.3. Ensure that the insulation on all cables and on the appliance is safe before connecting it to the power supply. See 1.1.1. and 1.1.2. and use a Portable Appliance Tester.
- 1.1.4. Ensure that cables are always protected against short circuit and overload.
- 1.1.5. Regularly inspect power supply cables and plugs for wear or damage and check all connections to ensure that none is loose.
- 1.1.6. **Important:** Ensure that the voltage marked on the appliance matches the power supply to be used and that the plug is fitted with the correct fuse - see fuse rating at right.
- 1.1.7. **DO NOT** pull or carry the appliance by the power cable.
- 1.1.8. **DO NOT** pull the plug from the socket by the cable.
- 1.1.9. **DO NOT** use worn or damaged cables, plugs or connectors. Immediately have any faulty item repaired or replaced by a qualified electrician. When an ASTA/BS approved UK 3 pin plug is damaged, cut the cable just above the plug and **dispose of the plug safely.** Fit a new plug according to the following instructions (UK only).
 - a) **Connect the GREEN/YELLOW earth wire to the earth terminal 'E'.**
 - b) **Connect the BROWN live wire to the live terminal 'L'.**
 - c) **Connect the BLUE neutral wire to the neutral terminal 'N'.**
 - d) **After wiring, check that there are no bare wires, that all wires have been correctly connected, that the cable outer insulation extends beyond the cable restraint and that the restraint is tight.**

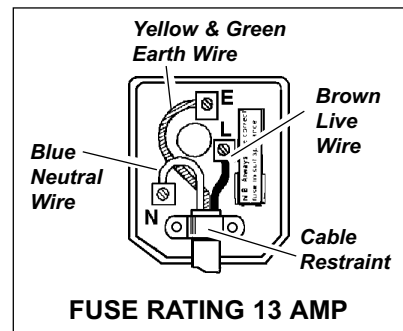

Double insulated products, which are always marked with this symbol , are fitted with live (brown) and neutral (blue) wires only. To rewire, connect the wires as indicated above - **DO NOT** connect either wire to the earth terminal.

- 1.1.10. Products which require more than 13 amps are supplied without a plug. In this case you must contact a qualified electrician to ensure that a suitably rated supply is available. We recommend that you discuss the installation of an industrial round pin plug and socket with your electrician.
- 1.1.11. If an extension reel is used it should be fully unwound before connection. A reel with an RCD fitted is preferred since any appliance plugged into it will be protected. The cable core section is important and should be at least 1.5mm², but to be absolutely sure that the capacity of the reel is suitable for this product and for others which may be used in the other output sockets, we recommend the use of 2.5mm² section cable. If extension reel is to be used outdoors, ensure it is marked for outdoor use.

1.2. GENERAL SAFETY

- WARNING! Disconnect drill from mains power before changing accessories, servicing or performing any maintenance.**
- ✓ Maintain the drill in good condition (use an authorised service agent).
- WARNING! Keep all guards and holding screws in place, tight and in good working order. Check regularly for damaged parts. A guard or any other part that is damaged should be checked, before the tool is used, to ensure that it will operate properly and perform its intended function. The safety guard is a mandatory fitting where drill is used in premises covered by the Health & Safety at Work Act.**
- ✓ Check alignment of moving parts and check for possible broken parts.
- ✓ Replace or repair damaged parts. *Use recommended parts only. Unauthorised parts may be dangerous and will invalidate the warranty.*
- ✓ Ensure the set screws of the head frame are screwed tight before using the drill.
- ✓ Secure the drill to the floor to avoid it tipping, sliding or walking.
- ✓ Drill is designed for use with drill bits only.
- ✓ Ensure the chuck is securely fastened to the spindle.
- ✓ Remove adjusting keys, chuck key and wrenches from the machine and working area before switching on.
- ✓ Use clamps or a vice (not included, but available from your Sealey dealer) to secure the workpiece. **DO NOT** attempt to hold the workpiece by hand.
- ✓ Refer to speed chart for recommended drilling speeds.
- WARNING! Always wear approved eye or face protection when operating this drill. Use a face or dust mask if dust is generated.**
- WARNING! DO NOT wear gloves when drilling.**

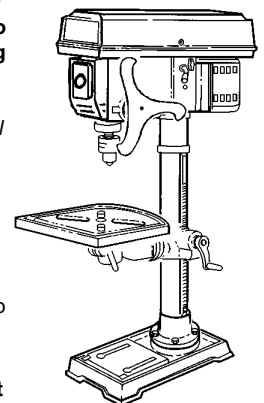

- ✓ Others in the workplace should keep a safe distance from the drill, especially when it is in operation.
- ✓ Keep the work area as childproof as possible by using padlocks and master switches.
- ✓ Keep drill bits clean and sharp for best and safest performance. Follow the instructions for lubrication and changing accessories.
- ✓ Remove ill fitting clothing. Remove ties, watches, rings and other loose jewellery and contain long hair.
- ✓ Locate the drill in a suitable work area, keep area clean and tidy and free from unrelated materials. Ensure there is adequate lighting.
- ✓ Maintain correct balance and footing. Ensure the floor is not slippery and wear non-slip shoes.
- ✓ Secure non-stable workpiece with a clamp, vice or other adequate holding device.
- ✓ Avoid unintentional starting.
- x **DO NOT** use the drill for a task it is not designed to perform.
- x **DO NOT** allow untrained persons to operate the drill.
- x **DO NOT** get the drill wet or use in damp or wet locations or areas where there is condensation.
- x **DO NOT** operate the drill if damaged.
- x **DO NOT** use drill in an area where paint fumes, solvents or flammable liquids pose a potential hazard. Keep flammable material away from the drill when operating. Flammable waste, such as wiping or cleaning rags, must be placed in a closed metal container and disposed of correctly.
- x **DO NOT** exceed the rated capacity of the drill.
- x **DO NOT** operate the drill if any parts are missing as this may cause failure and/or personal injury.
- x **DO NOT** leave the drill operating unattended.
- x **DO NOT** operate the drill when you are tired, under the influence of alcohol, drugs or intoxicating medication.
- x **DO NOT** pull the cable from the power supply.
- ✓ When not in use switch off the drill, remove plug from the power supply and do not leave until the drill chuck has come to a complete stop.

2. DESCRIPTION

These bench mounted variable speed drills are suitable for industrial, agricultural and woodworking applications. The drills are fitted with flip-up safety guards and "No-Volt Release" switches which prevent accidental restart after a mains power interruption. A rack and pinion feed shaft with preset depth control for repetitive work is also included. Morse taper spindles accept taper shank bits. Mortice attachments, work clamps and vices are also available for these drills, contact your local Sealey dealer for information. Model PDM155B has a built-in lamp to illuminate the drill bit and workpiece.

3. TECHNICAL SPECIFICATIONS

Model	PDM100B	PDM125B	PDM155B
Chuck size (mm)	16	16	16
Spindle Nose Taper	MT2	MT2	MT2
Swing (mm)	314	403	460
Chuck to Upright Face (mm)	127	165	190
Spindle Travel (mm)	60	80	80
Number of Speeds	12	16	16
Speed Range (rpm)	180 - 2740	190 - 3000	190 - 3000
Spindle to Table - max. (mm)	420	485	475
Spindle to Base - max. (mm)	540	700	660
Working Table (mm)	200 x 200	254 x 254	290 x 290
Working Base (mm)	165 x 155	205 x 200	205 x 200
Overall Base (mm)	345 x 210	450 x 270	495 x 290
Column Diameter (mm)	60	73	80
Overall Height (mm)	850	1050	1050
Voltage (AC)	230	230	230
Motor (W)	370	370	370

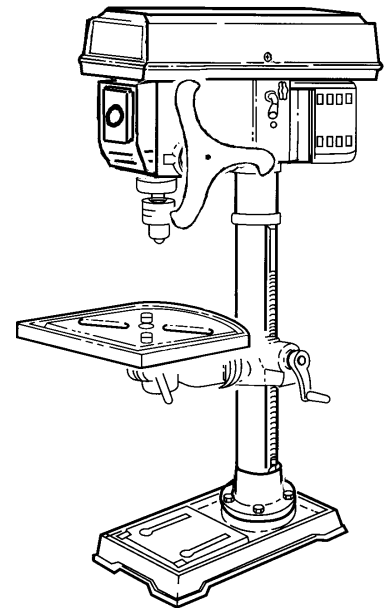

4. CONTENT

4.1. Package content

Unpack the parts listed below and check to ensure they are in good condition. Any queries must be reported to your dealer immediately.

- ✓ Head Assembly
- ✓ Column with Flange
- ✓ Adjusting Handle with Set Screw (table)
- ✓ Pivoted Clamp Bolts (2 - table arm & bracket)
- ✓ Arbor
- ✓ Wedge
- ✓ Base
- ✓ Feed Handle
- ✓ Table
- ✓ Bolts (4)
- ✓ Set Screws (2)
- ✓ Hex. Keys (2)
- ✓ Chuck and Key
- ✓ Table Arm, Bracket and Worm
- ✓ Rack and Rack Ring
- ✓ Safety Guard

5. ASSEMBLY

Note: Figures are illustrative and may differ in detail from your drill.

5.1. Assembly

- 5.1.1. Place the column assembly on the base, align holes and secure with the bolts provided.
- 5.1.2. Install table bracket onto column together with rack (fig.1), engaging gear in bracket with rack.
- 5.1.3. Install the rack collar and tighten firmly (fig.2).
- 5.1.4. Install the table adjusting handle (fig.2.A) and pivoted clamp bolt (the longer of the two - fig.2.B).
- 5.1.5. Tighten the handle set screw (with the hex. key provided) and the bracket clamp bolt.
- 5.1.6. Install the table and table pivoted clamp bolt to the table arm(fig.3). PDM100B only - table bolts directly to table bracket, there is no arm.
- 5.1.7. Carefully place the head assembly over the column and slide it into position. Align head with base.
- 5.1.8. Fit the two set screws in the side of the head and tighten with hex. key (fig.4) to lock head in position.
- 5.1.9. Fit the feed handle to the hub of the pinion shaft (align pin with slot) and retain with central screw.
- 5.1.10. To install chuck open the chuck jaws completely by turning the chuck key counter-clockwise. Place a piece of wood on the drill table (to prevent the chuck from getting damaged).
- 5.1.11. Insert arbor (fig.5 B) into drill spindle (reduced diameter end first), fit chuck to protruding end of arbor and hold in place.
- 5.1.12. Turn feed handle to bring nose of chuck down onto wood (fig.5). Firmly pull on feed handle to seat arbor tapers in spindle and chuck.
- 5.1.13. Loosen clamp screw on safety guard mounting collar, pass guard up over chuck and fit collar round flange of quill shaft. Ensure guard pivot is central and tighten clamp screw.

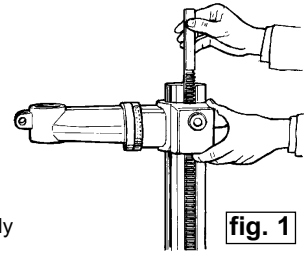
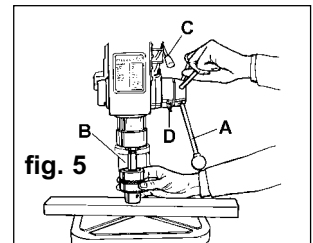
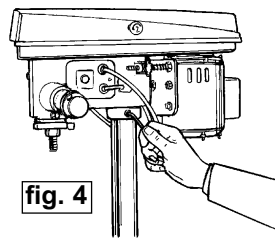
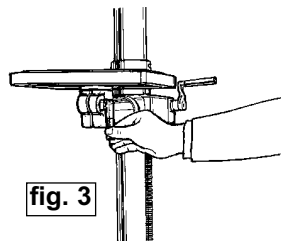
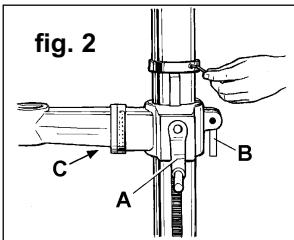

fig. 1

5.2. Drill mounting

- 5.2.1. **For stability and safety it is important** that the drill base is securely bolted to the workbench.
- 5.2.2. Ensure that the mounting surface is capable of supporting the drill together with the weight of the heaviest likely workpiece.



6. OPERATING INSTRUCTIONS

⚠ WARNING! Ensure the drill is unplugged from the mains power supply before commencing.

6.1. Install drill bit

- 6.1.1. Insert drill bit into chuck jaws to 1" (25mm) deep (avoid inserting small bits too far) and centre bit in chuck before tightening.

6.2. Adjusting the table

- 6.2.1. To adjust table up or down, loosen the clamp bolt (fig.2.B) then turn the bracket handle (fig.2.A).
- 6.2.2. To adjust table tilt, loosen the work table bolt (fig.2.C), adjust to the desired angle using the angle scale, then retighten bolt.
- 6.2.3. To turn the table around the column, loosen the rack collar slightly, then loosen the clamp bolt (fig.2.B). Turn the table to the desired position then secure the bolt and the rack collar.

6.3. Adjusting the speed

- 6.3.1. Open the pulley case and loosen the belt tension lock screws (fig.6.A) - one either side of head.
- 6.3.2. Choose the speed for drilling operation (see drill speed chart - Section 7) and move the belts to the correct position for that speed, as shown on the chart inside the pulley cover.

6.4. Belt tension

- 6.4.1. With the belt tension lock screws (fig.6.A) loose and using hand pressure on the adjusting handle (fig.5.C), set tension so that belt give is no more than 1/2" (13mm). Tighten lock screws.

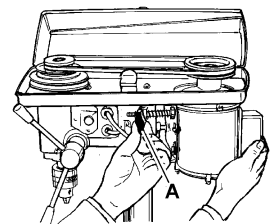

fig. 6

6.5. Positioning the workpiece

- 6.5.1. Use a piece of wood to rest the workpiece on. The drill bit may break through the workpiece and damage the table otherwise. The wood should rest on the table so that one end of it is against the left side of the column, to prevent it spinning when the drill bit breaks through the workpiece.
- 6.5.2. For small workpieces that cannot be clamped to the table, use a drill vice (not included). Vice must be clamped or bolted to table.

6.6. Setting the drill depth

- 6.6.1. Use the scale on the side of the drill head near the drill handle.
- 6.6.2. Loosen locking screw (fig.5.D) and set the scale to the depth desired. Tighten locking screw.
- 6.6.3. When ready to drill, simply pull the feed handle. The drill will stop at the set depth.

6.7. Illumination (PDM155B only)

- 6.7.1. The workpiece illumination is controlled by the rocker switch located immediately above the main power switch on the front of the head.

7. DRILL SPEEDS

Drill Dia. (mm)	Drill Speed (rpm)			
	Steel	Cast Iron	Iron	Alum. & Copper
3	1820	2580	2580	2580
4	1350	1820	1820	2580
5	1290	1350	1350	2580
6	970	1290	1290	2580
7	830	970	970	2580
8	830	970	970	2580
9	500	970	830	1820
10	500	830	830	1820
11	500	830	830	1820
12	420	830	500	1820
13	420	500	500	1350
14	420	500	500	1350
16	320	500	500	1290
18	320	420	420	1290
20	280	320	320	970
22	210	320	280	970
25	120	280	210	830

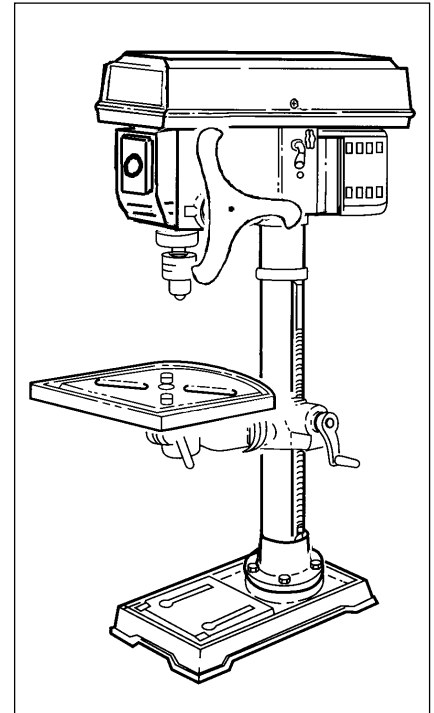

8. MAINTENANCE

- Clean the tool after each use. A coat of automobile-type wax applied to the table and column will help to keep the surfaces clean.
- Blow out any dust that may have accumulated in the motor.
- Periodically lubricate the table elevation rack/gear/worm mechanism and the spindle sleeve exterior.

9. TROUBLESHOOTING

PROBLEM	POSSIBLE CAUSE	SOLUTION
Excessive noise	<ol style="list-style-type: none"> Incorrect belt tension Spindle is dry Pulley is loose Bearing damaged 	<ol style="list-style-type: none"> Adjust tension Disassemble spindle/quill and lubricate Tighten pulley Replace the bearing
Excessive drill wobble	<ol style="list-style-type: none"> Chuck is loose Bearing or spindle shaft is worn Chuck is worn 	<ol style="list-style-type: none"> Tighten the chuck by pressing it against the table (see 5.2.12) Replace worn part Replace the chuck
Drill binds in the workpiece	<ol style="list-style-type: none"> Feed pressure is wrong Belt is loose Drill bit is loose Speed is too fast 	<ol style="list-style-type: none"> Apply less pressure Adjust tension Tighten the chuck jaws with the key Change the speed
Drill burns or smokes	<ol style="list-style-type: none"> Speed is too fast Chips are not discharging Drill bit is dull Lubrication needed Feed pressure is wrong 	<ol style="list-style-type: none"> Change the speed Clean the drill bit Use a new bit Lubricate while drilling Apply less pressure
Table is difficult to raise	<ol style="list-style-type: none"> Lubrication is needed Rack is bent 	<ol style="list-style-type: none"> Lubricate with light oil Straighten the rack

Bench Mounted Pillar Drills Models: PDM100B, PDM125B & PDM155B.

73/23/EEC Low Voltage Directive
89/336/EEC EMC Directive
98/37/EC Machinery Directive
93/68/EEC CE Marking Directive

Declaration of Conformity We, the sole importer into the UK, declare that the products listed here are in conformity with the following standards and directives.



Signed by Mark Sweetman

Date 1st November 1999

The construction files for these products are held by the Manufacturer and may be inspected, by a national authority, upon request to Jack Sealey Ltd.

For Jack Sealey Ltd. Sole importer into the UK of Sealey Quality Machinery.

NOTE: It is our policy to continually improve products and as such we reserve the right to alter data, specifications and component parts without prior notice.

IMPORTANT: No liability is accepted for incorrect use of this product.

WARRANTY: Guarantee is 12 months from purchase date, proof of which will be required for any claim.

INFORMATION: For our latest catalogue and promotions call us on 01284 757525 and leave your full name, address and postcode.



Sole UK Distributor,
Sealey Group,
Bury St. Edmunds,
Suffolk.



01284 757500



01284 703534

E-mail: sales@sealey.co.uk

Web: www.sealey.co.uk