



1.4/2.8KW INFRARED HALOGEN HEATER

MODEL NO : IR15

Thank you for purchasing a Sealey product. Manufactured to a high standard, this product will, if used according to these instructions, and properly maintained, give you years of trouble free performance.

IMPORTANT: PLEASE READ THESE INSTRUCTIONS CAREFULLY. NOTE THE SAFE OPERATIONAL REQUIREMENTS, WARNINGS & CAUTIONS. USE THE PRODUCT CORRECTLY AND WITH CARE FOR THE PURPOSE FOR WHICH IT IS INTENDED. FAILURE TO DO SO MAY CAUSE DAMAGE AND/OR PERSONAL INJURY AND WILL INVALIDATE THE WARRANTY. KEEP THESE INSTRUCTIONS SAFE FOR FUTURE USE.



Refer to
Instruction
Manual



Hot surfaces

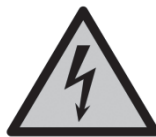

Warning:
Electricity



DO NOT
Cover



Indoor use only

1. SAFETY

1.1. ELECTRICAL SAFETY

- WARNING!** It is the user's responsibility to check the following:
Check all electrical equipment and appliances to ensure that they are safe before using. Inspect power supply leads, plugs and all electrical connections for wear and damage. Sealey recommend that an RCD (Residual Current Device) is used with all electrical products. You may obtain an RCD by contacting your local Sealey stockist.
If the product is used in the course of business duties, it must be maintained in a safe condition and routinely PAT (Portable Appliance Test) tested.

Electrical safety information, it is important that the following information is read and understood.

Ensure that the insulation on all cables and on the appliance is safe before connecting it to the power supply.

Regularly inspect power supply cables and plugs for wear or damage and check all connections to ensure that they are secure.

Important: Ensure that the voltage rating on the appliance suits the power supply to be used and that the plug is fitted with the correct fuse - see fuse rating in these instructions.

- * **DO NOT** pull or carry the appliance by the power cable.
- * **DO NOT** pull the plug from the socket by the cable.
- * **DO NOT** use worn or damaged cables, plugs or connectors. Ensure that any faulty item is repaired or is replaced immediately by a qualified electrician.

This product is fitted with a BS1363/A 13 Amp 3 pin plug.

If the cable or plug is damaged during use, switch off the electricity supply and remove from use.

Ensure that repairs are carried out by a qualified electrician.

Replace a damaged plug with a BS1363/A 13 Amp 3 pin plug. If in doubt contact a qualified electrician.

- a) Connect the GREEN/YELLOW earth wire to the earth terminal 'E'.
- b) Connect the BROWN live wire to the live terminal 'L'.
- c) Connect the BLUE neutral wire to the neutral terminal 'N'.

Ensure that the cable outer sheath extends inside the cable restraint and that the restraint is tight.

Sealey recommend that repairs are carried out by a qualified electrician.

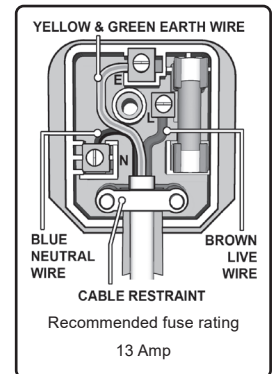

1.2. GENERAL SAFETY

CAUTION - Some parts of this product can become very hot and cause burns. Particular attention has to be given to where children and vulnerable children are present.

- WARNING!** To reduce the risk of fire, keep textiles, curtains or any other flammable material a minimum distance of 2m from the air outlet.
- WARNING!** Disconnect the heater from the mains power supply before carrying out any servicing or maintenance.
- ✓ Maintain the heater in good order and clean condition for best and safest performance. Replace or repair damaged parts.
- ✓ Locate heater in a suitable work area and keep area clean, tidy and free from unrelated materials. Ensure there is adequate lighting and keep the immediate area in front of the outlet grille clear.
- ✓ Allow the unit to cool before storage. When not in use, disconnect from the mains power supply and store in a safe, cool, dry, childproof area.
- ✓ Use this heater on a horizontal and stable surface.
- * **DO NOT** use the heater where there are flammable liquids, solids or gases such as petrol, solvents, aerosols etc, or where heat sensitive materials may be stored.
- * **DO NOT** place the heater near items that may be damaged by heat, allow at least 2m clearance in front of the heater.
- * **DO NOT** allow the heater to get wet as this may cause an electric shock, causing damage to the heater and possible personal injury.
- * **DO NOT** use this heater in small rooms when they are occupied by persons not capable of leaving the room on their own, unless constant supervision is provided.
- * **DO NOT** let power lead hang over an edge (i.e. table), or touch a hot surface, lie in the beam of heat, or run under a carpet.
- * **DO NOT** use this heater in the immediate surroundings of a bath, a shower or a swimming pool.
- * **DO NOT** operate the heater when you are tired or under the influence of alcohol, drugs or intoxicating medication.
- * **DO NOT** insert or allow objects to enter any openings of heater as this may cause an electric shock, fire or damage to heater.
- * **DO NOT** use heater if the power cord, plug or the heater is damaged, or if the heater has become wet.
- * **DO NOT** use the heater for any purpose other than for which it is designed.

- ✗ **DO NOT** use the heater with a programmer, timer or any other device that switches the heater on automatically.
- ✗ **DO NOT** touch the lamps, even when cold.
- ✗ **DO NOT** use the heater without the wheels fitted and locked.
- ✗ **DO NOT** allow children to touch or to operate the heater.
- ✗ **DO NOT** locate the heater below an electrical socket outlet.
- ✗ **DO NOT** use the heater without the grille fitted.
- ✗ **DO NOT** use the heater out of doors. These heaters are designed for indoor use only.
- ✗ **DO NOT** use this heater if it has been dropped.
- ✗ **DO NOT** use if there are visible signs of damage to the heater.
- ✗ **DO NOT** cover heater when in use, and do not obstruct the air inlet and outlet grilles.
- ✗ **DO NOT** place heater too close to yourself or any object, allow the air to circulate freely.
- ✗ **DO NOT** touch the outlet grille of the heater during and immediately after use as it will be hot.
- ✓ Children of less than 3 years should be kept away unless continuously supervised.
- ✓ Children aged from 3 years and less than 8 years shall only switch on/off the appliance provided that it has been placed or installed in its intended normal operating position and they have been given supervision or instruction concerning the use of the appliance in a safe way and understand the hazards involved. Children aged from 3 years to less than 8 shall not plug in, regulate and clean the appliance or perform user maintenance.
- ✓ This appliance can be used by children aged from 8 years and above and persons with physical, sensory or mental capabilities or lack of experience and knowledge if they have been given supervision or instruction concerning the use of the appliance in a safe way and understand the hazards involved. Children shall not play with the appliance. Cleaning and user maintenance shall not be made by children without supervision.

2. INTRODUCTION

Powder coated metal construction with tilting head giving directional heat control. Adjustable thermostat control (15°C – 45°C). Soft-touch control panel with LED display. Programmable 7-day timer function. Equipped with a tilt cutout switch for added safety. Fitted with two ruby halogen infrared elements and chemically polished reflectors for maximum heat emission. Stand features easy-rolling castors with a locking castor fitted to the rear. Suitable for a wide range of heating including restorative applications. Supplied with cable and 3-pin plug.

3. SPECIFICATION

Dimensions (W x D x H)..... Heater: 597 x 488 x 792mm
 Power..... 1400-2800W
 Supply..... 230V - 13A

4. ASSEMBLY

- 4.1. Fit the handle section of the support frame to the wheel section ensuring the fixing holes align. Refer to Parts List.
- 4.2. Fit the heater to the support frame using the bolts provided, ensuring the shaped spacers are fitted either side of the frame as shown. Tighten the bolts sufficiently to retain the heater at the required angle.
- 4.3. Remove the front grille by unscrewing the retaining screws.
- 4.4. **WARNING!** Never touch element glass directly with fingers, only touch the ceramic ends or use a soft cloth, to prevent damage.
- 4.5. Carefully insert each element into the two push-in side fittings with a gentle pressure.
- 4.6. Check the element is properly located, then replace front grille.

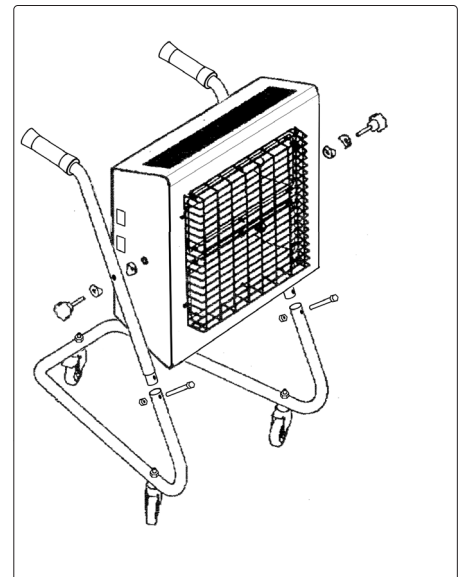

5. OPERATION

- 5.1. Place the heater on a level floor in the area you require to heat. Allow a minimum of 2 metres between the heater and adjacent objects.
- 5.2. Plug the heater into the mains supply and turn on the unit using the side mounted rocker switch.
- 5.3. To switch the unit off, select "0" on the rocker switch and unplug from the mains. Allow the unit to cool before handling or storage.

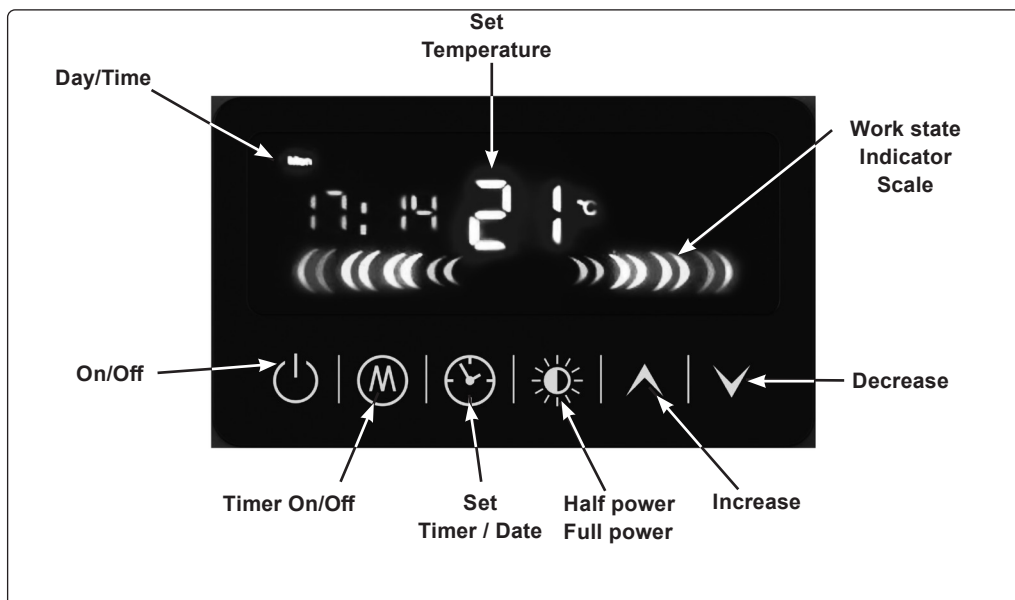



- ❑ **WARNING! DO NOT** touch the top of the heater when in use as it becomes hot.
 - ❑ **WARNING!** Always allow elements to cool before moving the units. Use only on a smooth even surface. Failure to do so will cause premature wear to the lamps and reduce their working life.
- 5.4. The heater has a built in tilt switch safety mechanism that switches off the unit if it is tilted beyond 35° either forwards or backwards. This prevents fire in the event of the unit being knocked over. The heater requires manual input to restart e.g. it does not restart automatically.

- ❑ **WARNING! DO NOT** use this heater in small rooms when they are occupied by persons not capable of leaving the room on their own, unless constant supervision is provided.

- 5.5. Place the heater on a level floor in the area you require to heat.
 5.6. Allow a minimum of 2m between the heater and adjacent objects.



5.7. POWER ON/OFF

- 5.7.1. Connect to mains supply turn on red rocker switch.
 5.7.2. Heater is in standby screen shows 'OF'.
 5.7.3. Press  to start heater. Screen shows: week, time, ambient temperature and power indication.

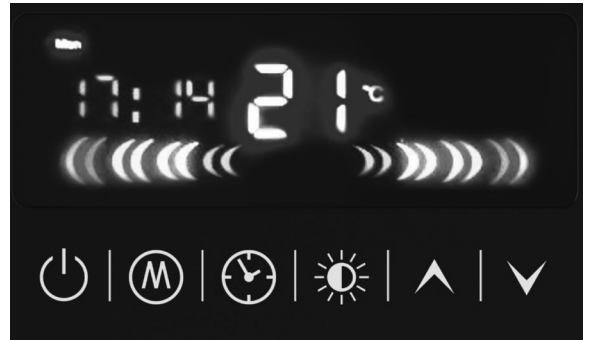
- 5.7.4. Press  again heater turns off, returns to standby screen shows 'OF'.



5.8. SETTING TEMPERATURE

- 5.8.1. Default temperature at power on is 30°C.
 5.8.2. Press  or  to set temperature. One press = 1°C. Screen shows temperature only. Range is 15 to 45°C.
 5.8.3. After 5 seconds screen defaults to ambient temperature.
 5.8.4. Next setting will be based on the previous set temperature.
 5.8.5. Heater will only work when ambient is lower than the set temperature.

5.9. SETTING POWER

- 5.9.1. Heater has 3 power settings selected by pressing .

5.9.2. POWER SETTING 1 TOP ELEMENT ON

Screen displays:



5.9.3. POWER SETTING 2 BOTTOM ELEMENT ON

Screen displays:





























5.9.4. POWER SETTING 3 BOTH ELEMENTS ON

Screen displays:



5.10. SETTING CURRENT DATE AND TIME

- 5.10.1. After power on press  for 3 seconds to set current date and time.
 5.10.1. When **DAY** symbol (Mon to Sun) flashes, press  |  to select day.
 5.10.2. Press  again to select **HOUR** by pressing  | 
 5.10.3. Press  again to select **MINUTES** by pressing  | 

- 5.10.4. Press  to save the date and time or wait 5 seconds without pressing the buttons and selected day and time will be saved .
- 5.10.5. Repeat above procedure to reset day and time.
- 5.11. SETTING DAYS OF WEEK WORKING TIME MODES**
- 5.11.1. Power on. Press  **once** to set days of the week timer.
- 5.11.2. When **MON** flashes select days of the week by pressing  
- 5.11.3. Heater has 7 daily programs and 3 working time modes can be set up within each day.
- 5.11.4. Press  again and select working time modes 01, 02 03 by pressing  
- 5.11.5. Press  again to set the timer for power on (hours first, then minutes) by pressing  
- 5.11.6. Press  again to set the timer for power off. Operation is the same as above (selected using  )
- 5.11.7. Then press  again to set temperature. Default temperature setting is 30°C.
- 5.11.8. Press  again to finish the timer setting for that day. Repeat the above procedure for other days.
- 5.11.9. Press  to activate or deactivate the days of week working time modes. When week and time symbols are both displayed it means the days of week working time mode is active.
- 5.11.10. Repeat above procedures to change weekly working time modes timer.
- 5.11.11. RESET**
Enter process as far as day selection then press  for 3 seconds, all existing set programs for that day will be deleted. Users can only reset existing programs day by day.

5.12. OPEN WINDOW DETECTION FUNCTION

- 5.12.1. When ambient temperature drops over 5°C in 10 minutes, heater will power off automatically and sound 3 alarm beeps. Power on again by pressing 
- 5.13. All set programs will be stored even if the power is off.
- 5.14. Temperature is only adjustable when the days of week working time modes is inactive.
- 5.15. Clock continues to work after power off. Charge battery after 12 hours of initial use (standby and working modes will both charge the battery).
- 5.16. Should the power cord require replacement, a complete wiring loom should be purchased and fitted by a suitably qualified person.

6. MAINTENANCE

- WARNING!** Before attempting any maintenance ensure the unit is unplugged from the mains power supply, it is cool and on level ground.
 - × **DO NOT** touch the element glass, even when cold.
 - × **DO NOT** use the heater with out the grilles fitted.
- 6.1. To clean the reflector, remove the front grill by unscrewing the retaining screws and wipe the reflector with a clean dry cloth. **DO NOT** use abrasives or solvents. The surface of the reflector is very soft and scratches may cause it to overheat. Replace the grille.
- 6.2. To change the element remove the front grille by unscrewing the retaining screws.
- 6.2.1. Ease the sprung sockets on the ends of the element back and pull the element forward so that it clears the socket, remove element.
- WARNING!** Never touch element glass directly with fingers, only touch the ceramic ends or use a soft cloth, to prevent damage.
- 6.2.2. Carefully insert the replacement lamp into the two push in side fittings with gentle pressure.
- 6.3. BATTERY REPLACEMENT**
- 6.4. Refer to Parts Diagram. Battery is located on the lower PCB. It is recommended that this is replaced by a suitable qualified person.
- 6.4.1. Check the element is properly located, then replace front grille.



WEEE REGULATIONS

Dispose of this product at the end of its working life in compliance with the EU Directive on Waste Electrical and Electronic Equipment (WEEE). When the product is no longer required, it must be disposed of in an environmentally protective way. Contact your local solid waste authority for recycling information.



ENVIRONMENT PROTECTION

Recycle unwanted materials instead of disposing of them as waste. All tools, accessories and packaging should be sorted, taken to a recycling centre and disposed of in a manner which is compatible with the environment. When the product becomes completely unserviceable and requires disposal, drain any fluids (if applicable) into approved containers and dispose of the product and fluids according to local regulations.

Note: It is our policy to continually improve products and as such we reserve the right to alter data, specifications and component parts without prior notice. Please note that other versions of this product are available. If you require documentation for alternative versions, please email or call our technical team on technical@sealey.co.uk or 01284 757505.

Important: No Liability is accepted for incorrect use of this product.

Warranty: Guarantee is 12 months from purchase date, proof of which is required for any claim.

Sealey Group, Kempson Way, Suffolk Business Park, Bury St Edmunds, Suffolk. IP32 7AR



01284 757500



01284 703534



sales@sealey.co.uk



www.sealey.co.uk



Information requirements for electric local space heaters

| Model identifier(s): IR15.V1 | | | | | |
|---|-------------|-------|------|---|--|
| Item | Symbol | Value | Unit | Item | Unit |
| Heat output | | | | Type of heat input, for electric storage local space heaters only (select one) | |
| Nominal heat output | P_{nom} | 2.7 | kW | Manual heat charge control, with integrated thermostat | Yes No <input checked="" type="checkbox"/> |
| Minimum heat output (indicative)* * Enter figure or NA | P_{min} | N/A | kW | Manual heat charge control with room and/or outdoor temperature feedback | Yes No <input checked="" type="checkbox"/> |
| Maximum continuous heat output | $P_{max,c}$ | N/A | kW | Electronic heat charge control with room and/or outdoor temperature feedback | Yes No <input checked="" type="checkbox"/> |
| | | | | Fan assisted heat output | Yes No <input checked="" type="checkbox"/> |
| Auxiliary electricity consumption | | | | Type of heat output/room temperature control (select one) | |
| At nominal heat output | eI_{max} | 2.614 | kW | Single stage heat output and no room temperature control | Yes No <input checked="" type="checkbox"/> |
| At minimum heat output | eI_{min} | N/A | kW | Two or more manual stages, no room temperature control | Yes No <input checked="" type="checkbox"/> |
| In standby mode | eI_{SB} | 0.00 | kW | With mechanic thermostat room temperature control | Yes No <input checked="" type="checkbox"/> |
| | | | | With electronic room temperature control | Yes No <input checked="" type="checkbox"/> |
| | | | | Electronic room temperature control plus day timer | Yes No <input checked="" type="checkbox"/> |
| | | | | Electronic room temperature control plus week timer | Yes <input checked="" type="checkbox"/> No |
| | | | | Other control options (multiple selections possible) | |
| | | | | Room temperature control, with presence detection | Yes No <input checked="" type="checkbox"/> |
| | | | | Room temperature control, with open window detection | Yes <input checked="" type="checkbox"/> No |
| | | | | With distance control option | Yes No <input checked="" type="checkbox"/> |
| | | | | With adaptive start control | Yes No <input checked="" type="checkbox"/> |
| | | | | With working time limitation | Yes <input checked="" type="checkbox"/> No |
| | | | | With black bulb sensor | Yes No <input checked="" type="checkbox"/> |
| Contact details: Sealey Group, Kempson Way, Suffolk Business Park, Bury St Edmunds, Suffolk, IP32 7AR. www.sealey.co.uk | | | | | |
| v1 | | | | ERP Table 2 | |