



## INSTRUCTIONS FOR

# SPRAY GUNS, GRAVITY FEED 1.8MM, 2.2MM SET UP

MODEL NO: **SSG501.V4, SSG502.V2**

Thank you for purchasing a Sealey product. Manufactured to a high standard, this product will, if used according to these instructions, and properly maintained, give you years of trouble free performance.

**IMPORTANT:** PLEASE READ THESE INSTRUCTIONS CAREFULLY. NOTE THE SAFE OPERATIONAL REQUIREMENTS, WARNINGS & CAUTIONS. USE THE PRODUCT CORRECTLY AND WITH CARE FOR THE PURPOSE FOR WHICH IT IS INTENDED. FAILURE TO DO SO MAY CAUSE DAMAGE AND/OR PERSONAL INJURY AND WILL INVALIDATE THE WARRANTY. KEEP THESE INSTRUCTIONS SAFE FOR FUTURE USE.



Refer to instructions



Wear eye protection



Wear protective gloves



Wear safety footwear



Wear protective clothing



Wear respiratory protection

## 1. SAFETY

- WARNING!** Disconnect the spray gun from the air supply before changing accessories, servicing or performing any maintenance.
- ✓ Paint cup remains pressurised after gun is disconnected from air line. **DO NOT** pull the trigger, but depressurise by gently opening cup.
- ✓ Maintain the spray gun in good condition (use an authorised service agent).
- ✓ Replace or repair damaged parts. Use recommended parts only. Unauthorised parts may be dangerous and will invalidate the warranty.
- ✓ Locate the spray gun in an adequate working area for its function, keep area clean and tidy and free from unrelated materials and ensure there is adequate ventilation and lighting.
- ✓ Keep the spray gun clean for best and safest performance.
- ✓ Ensure the air system is suitable to the spray gun air consumption, (see specifications).
- ✓ Wear approved respiratory protection and safety eye goggles.
- ✓ Wear appropriate protective overalls, gloves and boots
- ✓ Keep children and unauthorised persons away from the working area.
- ✓ When not in use ensure the air supply is turned off.
- ✓ Avoid unintentional operation.
- \* **DO NOT** point spray gun at yourself, at other persons or animals.
- \* **DO NOT** carry by the air hose, or yank the hose from the air supply.
- \* **DO NOT** use the spray gun for any purpose other than for which it is designed.
- \* **DO NOT** allow untrained persons to operate the spray gun.
- \* **DO NOT** get the spray gun wet or use in damp or wet locations or areas where there is condensation.
- \* **DO NOT** operate gun if any parts are missing or damaged as this may cause failure or personal injury.
- \* **DO NOT** direct air from the air hose at yourself or others.



## 2. INTRODUCTION

Ideal for applying undercoats, primers and adhesives. Features adjustable paint flow and fan width controls. Supplied with composite gravity feed pot. Suitable for use with water borne paints. Alternative set-ups available separately.

## 3. SPECIFICATION

Model No: . . . . .	<b>SSG501.V4</b> . . . . .	<b>SSG502.V2</b>
Standard Set Up: . . . . .	2.2mm . . . . .	1.8mm
Available Set Ups: . . . . .	1.5, 1.8mm. . . . .	1.5, 2.2mm
Air Pressure: . . . . .	50psi . . . . .	50psi
Air Consumption: . . . . .	4.5-8cfm. . . . .	4.5-8cfm
Pot Capacity: . . . . .	600ml. . . . .	600ml

## 4. AIR SUPPLY CONNECTION

- 4.1. Air Supply
  - 4.1.1. Ensure spray gun air valve (or trigger) is in the "off" position before connecting to the air supply.
  - 4.1.2. You will require an air pressure of 50psi and an air flow according to specification.
    - WARNING!** Ensure the air supply is clean and does not exceed 50psi while operating the spray gun. Too high an air pressure and unclean air will shorten the product life due to excessive wear and may be dangerous causing damage and/or personal injury. Drain the air tank daily. Water in the air line will ruin the paint finish and damage the spray gun.
  - 4.1.3. Clean air inlet filter weekly. Recommended hook-up procedure is shown in fig.1.
  - 4.1.4. Line pressure should be increased to compensate for unusually long air hoses (over 8 metres). The minimum hose diameter should be 1/4" I.D. and fittings must have the same inside dimensions.
  - 4.1.5. Keep hose away from heat, oil and sharp edges. Check hose for wear and make certain that all connections are secure.
- 4.2. Couplings.
  - Do not fit a quick change coupling directly to the spray gun. A leader hose should be fitted to the spray gun and then a quick change coupling may then be used to connect the leader hose to the air line recoil hose. See fig.1 & 2.

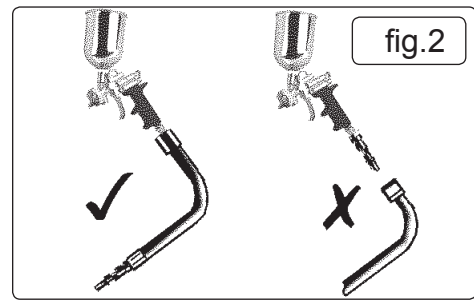
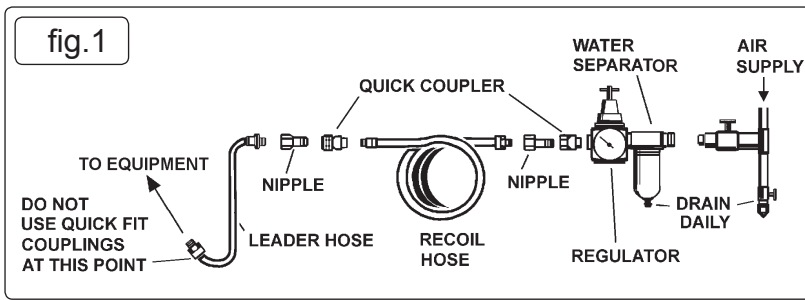

## 5. OPERATION

- 5.1. For best results, make sure to handle the gun correctly. It should be held perpendicular to the surface being sprayed and moved parallel to it. Start the stroke before squeezing the trigger and release the trigger before finishing the stroke. This will enable you to accurately control the gun and material (fig.3).
- 5.2. Spray from a distance of about 150mm (6") to 250mm (10") depending on the material and the atomizing pressure. The material deposited should always be even and wet. Each stroke must overlap the preceding stroke to obtain a uniform finish. To reduce over spray and obtain maximum efficiency, spray with the lowest possible atomizing air pressure.
- 5.3. Controlling the fan spray and the fluid.
  - a) The atomizing air flow is controlled by using the regulator attached to the incoming air supply which should be capable of supplying between 5 and 11cfm.
  - b) Use the adjustment knob (fig.4.4) to increase or decrease the amount of paint flowing in from the gravity feed pot.
  - c) The width of the spray can be adjusted using knob (fig.4.5).
  - d) As width of spray is increased more material must pass through the gun to obtain the same coverage on the increased area.
  - e) Turn the air nozzle (fig.4.1) to achieve a horizontal or vertical fan spray. Lock the nozzle with retaining ring (fig.4.2).

The spray pattern of the gun is variable from round to flat with all patterns in between. In normal operation, the wings on the nozzle are horizontal as fig.4, this provides a vertical fan-shaped pattern which gives maximum uniform and even coverage when moving the gun back and forth, parallel to the work surface (fig.5).

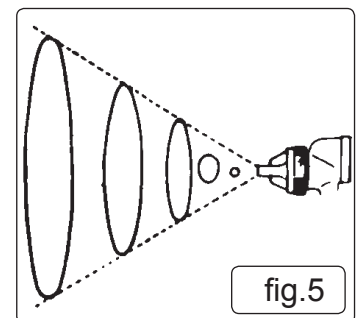
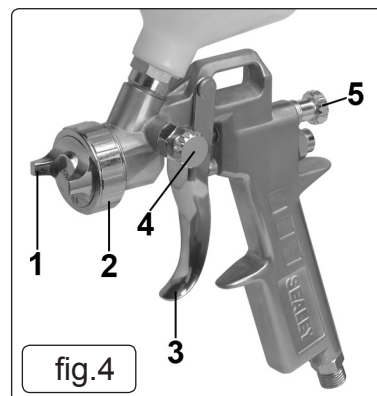
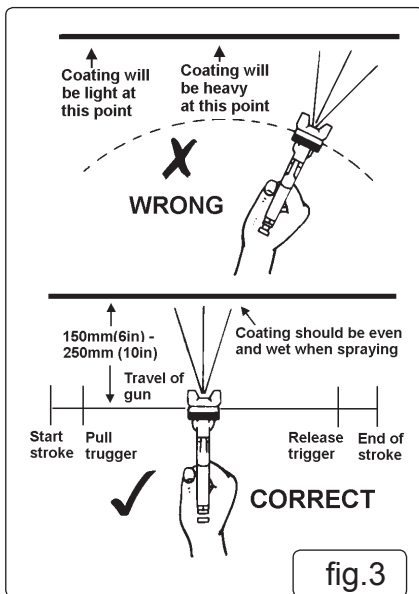

## 6. CLEANING & MAINTENANCE

FOR OPTIMUM PERFORMANCE IT IS VERY IMPORTANT TO ENSURE THE GUN IS CORRECTLY CLEANED AFTER EACH USE. Disconnect from the air supply before attempting any cleaning or maintenance.

- 6.1. **Cleaning the gun**
  - 6.1.1. Immerse the front end of the gun only in solvent. The solvent should just cover the fluid connection.
  - 6.1.2. Use a bristle brush and solvent to wash off accumulated paint.
  - 6.1.3. **DO NOT** immerse the entire gun in solvent as this will cause lubricants on the rubber seals to dissolve. Dirty solvent may also clog narrow passages in the gun.
  - 6.1.4. Flush the gun through with clean thinners.
  - 6.1.5. Wipe the outside of the gun with a dampened solvent rag.
- 6.2. **Air nozzle, fluid nozzle and needle assembly**
  - 6.2.1. To clean the nozzles, soak them in solvent to dissolve any dried material then blow them clean with air. Handle all nozzles carefully and do not make any alterations in the gun.
  - 6.2.2. If you need to probe the holes in the nozzles, be sure to use a tool that is softer than brass; do not use metal instruments.
  - 6.2.3. Adjust the fluid needle valve so that when the gun is triggered, air flow occurs before fluid flow.

6.3. **Maintenance**





Take care when re-assembling. Screw parts hand tight to avoid cross-threading. If a part cannot easily be turned by hand, check that you have the correct part, or unscrew, realign and try again. **DO NOT** use excessive force when re-assembling.

6.3.1. Lubricate the gun daily with a light machine oil.

6.3.2. If you change the nozzle size, ensure the complete nozzle set is exchanged. Insert paint nozzle before putting the paint needle in.

6.3.3. To change the needle packing use the socket spanner provided. Note: Handle the teflon seal and self tensioning spring with care.

**7. TROUBLESHOOTING**

View of Problem	Possible Reason for problem	Solution
	Dried material in a dirty side port restricts passage of air. Greater flow of air from the clean side port forces a fan pattern in the direction of the clogged side.	Dissolve material in the side ports with thinner, then blow the gun clean. Do not poke into the opening with metal instruments.
	Dried material around the outside of the fluid nozzle tip restricts the passage of atomizing air at one point through the centre opening of the air nozzle and results in the pattern shown.	Remove the air nozzle and wipe off fluid tip using
	A split spray or one that is heavy on each end of a fan pattern and weak in the middle is usually caused by too high an atomising air pressure or by attempting to get too wide a spray with thin material.	Check supply pressure and reduce if over 50psi. Adjust paint needle if required. Check spray pattern on a test panel.
	Dirt between the fluid nozzle seat and body or loosely installed fluid nozzle will cause the gun to spit.	Remove the fluid nozzle, clean the back of the nozzle and the nozzle seat in the gun body using a rag dampened with thinners. Replace the nozzle and secure it tightly against the body.
<b>Material bubbles in paint</b>	Atomise air flowing through the paint channel to pot. The paint nozzle is not tight enough. Air nozzle not completely screwed in. The air inlet seal is defective or nozzle insert is damaged.	Tighten, clean or replace parts accordingly.

**Parts support is available for this product. To obtain a parts listing and/or diagram, please log on to [www.sealey.co.uk](http://www.sealey.co.uk), email [sales@sealey.co.uk](mailto:sales@sealey.co.uk) or telephone 01284 757500.**



**Environmental Protection**

Recycle unwanted materials instead of disposing of them as waste. All tools, accessories and packaging should be sorted, taken to a recycling centre and disposed of in a manner which is compatible with the environment. When the product becomes completely unserviceable and requires disposal, drain off any fluids (if applicable) into approved containers and dispose of the product and the fluids according to local regulations.

**NOTE:** It is our policy to continually improve products and as such we reserve the right to alter data, specifications and component parts without prior notice.

**IMPORTANT:** No liability is accepted for incorrect use of this product.

**WARRANTY:** Guarantee is 12 months from purchase date, proof of which will be required for any claim.



Sole UK Distributor, Sealey Group.  
Kempson Way, Suffolk Business Park,  
Bury St. Edmunds, Suffolk.  
IP32 7AR



01284 757500



01284 703534



[www.sealey.co.uk](http://www.sealey.co.uk)



[sales@sealey.co.uk](mailto:sales@sealey.co.uk)