

Thank you for purchasing a Sealey product. Manufactured to a high standard this product will give you years of trouble free performance if these instructions are carefully followed and the product is correctly maintained.



IMPORTANT: PLEASE READ THESE INSTRUCTIONS CAREFULLY. NOTE THE SAFE OPERATIONAL REQUIREMENTS, WARNINGS AND CAUTIONS. USE THIS PRODUCT CORRECTLY AND WITH CARE FOR THE PURPOSE FOR WHICH IT IS INTENDED. FAILURE TO DO SO MAY CAUSE DAMAGE OR PERSONAL INJURY AND WILL INVALIDATE THE WARRANTY. PLEASE RETAIN THESE INSTRUCTIONS FOR FUTURE USE.

1. SAFETY INSTRUCTIONS

- WARNING!** Ensure health & safety, local authority, and general workshop practice regulations are strictly adhered to when using this equipment.
- ✓ Familiarise yourself with product application and limitations, as well as the specific potential hazards peculiar to this product.
- ✓ Maintain the meter in good condition (use an authorised service agent).
- ✓ Replace or repair damaged parts. Use genuine parts only. Non authorised parts will invalidate the warranty.
- ✓ Use only to meter water/urea solutions.
- ✓ Ensure safety eye protection and protective clothing are worn when using this product.
- ✓ Keep the work area clean, uncluttered and ensure there is adequate lighting.
- ✓ Maintain correct balance and footing. Ensure the floor is not slippery and wear non slip shoes.
- ✓ Keep children and unauthorised persons away from the working area.
- ✓ After use, drain any fluids from the equipment before storage.
- ✓ Dispose of waste liquids in accordance with local authority regulations.
- x **DO NOT** exceed the maximum pressure of 10bar.
- x **DO NOT** use the equipment near open flames.
- x **DO NOT** smoke whilst using this equipment.
- x **DO NOT** use for corrosive fluids.
- x **DO NOT** dismantle, tamper with or adapt the equipment for any purpose other than for which it is designed.
- x **DO NOT** use the unit if it has been dropped or mishandled, check the unit to ensure there is no damage.
- x **DO NOT** use taper connections, use parallel connectors only.
- x **DO NOT** use compressed air on the turbine, the excessive rotation will damage the unit.
- ✓ Keep the meter clean and store in a safe dry, childproof location.
- WARNING! DO NOT** allow uncontrolled discharge of fluids thus polluting the environment. All liquids must be disposed of according to local authority regulations.



2. INTRODUCTION

Robust rubber housing with integral digital electronic metering. Easy to read large, four digit, 28mm high LCD display calibrated in litres. Features flow rate indication. 1"x1"BSP Male / Female fittings. Suitable for use with AdBlue®. Powered by 2 x AAA batteries (supplied). IP65 Rated protection.

Measurement system	Turbine (Polypropylene)
Flow Rate (Range)	5~ 100 ltr/min
Operating pressure (Max)	10bar
Bursting pressure (Min)	40bar
Storage temperature (Range)	-20°C to 70°C
Storage humidity (Max)	95%
Operating temperature (Range)	-10°C to 50°C
Flow resistance	0.30bar at 100 ltr/min
Viscosity (Range)	2 to 5.35 cSt
Accuracy (between 15 and 120l/min)	+/-1% of value indicated after calibration
Reproducibility (Typical)	+/- 0.3%
Power supply	2 x 1.5V AAA alkaline batteries
Battery life	18 to 36 months
Weight	0.25kg (including batteries)
Compatible Fluids	Water, Urea

3. INSTALLATION

3.1 Installing Into System

3.1.1 Connect the ADB02 into the system, ensuring that the arrow on the side of the meter is pointing in the direction of the flow.

Note: Use 1" BSP threaded connectors only, **DO NOT** use taper threaded connectors.

Note: To improve the life of the turbine, a strainer should be fitted upstream of the meter.

3.1.2 The fascia of the meter can be rotated to match the orientation of the meter (fig.1). Remove the four screws from the front of the unit and carefully separate from the rubber protection surround, rotate the fascia to the desired position taking care not to trap the wires against the reed switch (fig.2.1), push gently into the rubber surround and refit the screws.

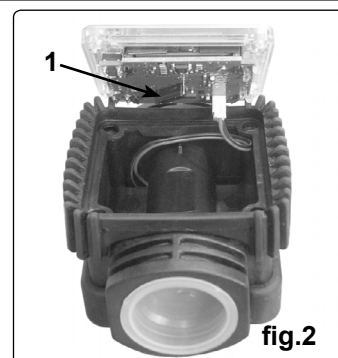
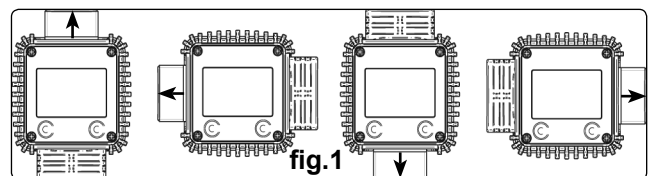

3.2 LCD Display

The "LCD" of the METER features two numerical registers and various indications displayed to the user only when the applicable function so requires.

Key:

1. Partial register (5 figures with moving comma FROM 0.1 to 99999) indicating the volume dispensed since the reset button was last pressed.
2. Indication of battery charge.
3. Indication of calibration mode.
4. Totals register (6 figures with moving comma FROM 0.1 to 999999), that can indicate two types of Total:
 - 4.1. General Total that cannot be reset (TOTAL).
 - 4.2. Resettable total (Reset TOTAL).
5. Indication of total multiplication factor (x10 / x100).
6. Indication of type of total, (TOTAL / Reset TOTAL).
7. Indication of unit of measurement of Totals: L=Litres Gal=Gallons
8. Indication of Flow Rate mode.
9. Indication of unit of measurement of Partial: Qts=Quarts Pts=Pints L=Litres Gal=Gallons

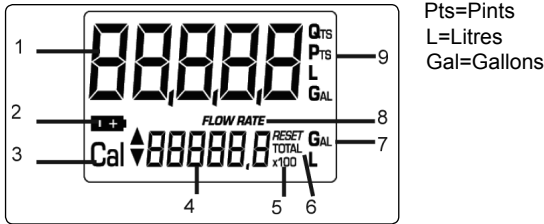

User Buttons

The ADB02 features two buttons (reset and cal) which individually perform two main functions and, together, other secondary functions.

The main functions performed are:

- Reset key - resetting the partial register and resettable total (reset total).
- Cal key - entering instrument calibration mode.

Used together, the two keys permit entering configuration mode, useful for changing the units of measurements and calibration factor.

4. OPERATION

4.1 Daily Use

The only operations that need to be done for daily use are partial and/or resettable total register resetting. The user should use only the dispensing system of ADB02. Occasionally the meter may need to be configured or calibrated. To do so, please refer to the relevant sections. Below are the two typical normal operation displays. One display page shows the partial and reset total registers. The other shows the partial and general total. Switchover from resettable total to general total display is automatic and tied to phases and times that are factory set and cannot be changed.

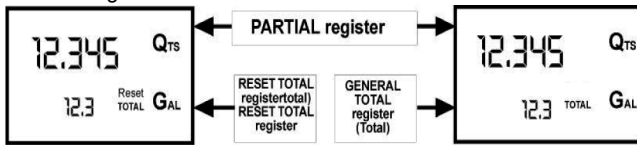

NOTE: 6 digits are available for Totals, plus two icons x 10 / x100. The increment sequence is the following:
 0.0 → 99999.9 → 999999 → 100000 x 10 → 999999 x 10 → 100000 x 100 → 999999 x 100

4.2 Dispensing in Normal Mode

Normal mode is the standard dispensing. While the count is made, the partial and resettable total are displayed at the same time (reset total).

Should one of the keys be accidentally pressed during dispensing, this will have no effect.

A few seconds after dispensing has ended, on the lower register, the display switches from resettable total to general total: the word reset above the word total disappears, and the reset total is replaced by the general total.

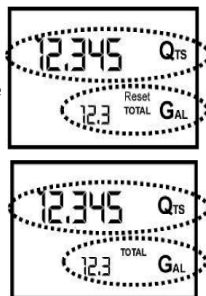

This puts the meter in standby mode and remains stable until the user operates the ADB02 again.

4.2.1 Partial Reset

The partial register can be reset by pressing the reset key when the meter is in standby, meaning when the display screen shows the word "TOTAL".



After pressing the reset key, during reset, the display screen first of all shows all the lit-up digits and then all the digits that are not lit up.

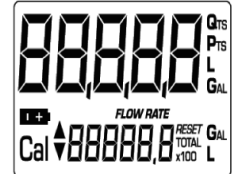

At the end of the process, a display page is shown with the reset partial and the reset total.



After a few moments, the reset total is replaced by the non resettable Total.

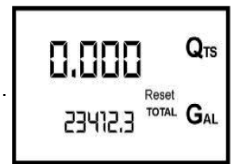

4.2.2 Resetting the Reset Total

The reset total resetting operation can only be performed after resetting the partial register. The reset total can in fact be reset by pressing the reset key at length while the display screen shows reset total as on the following display page:



Schematically, the steps to be taken are:

1. Wait for the display to show normal standby display page (with total only displayed).
2. Press the reset key quickly.
3. The meter starts to reset the partial.
4. While the display page showing the reset total is displayed. Press the reset key again for at least 1 second.
5. The display screen again shows all the segments of the display followed by all the switched-off segments and finally shows the display page where the reset Reset Total is shown.

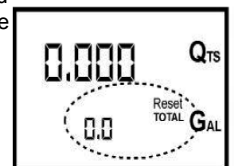
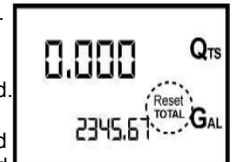

4.3 Dispensing with Flow Rate Mode Display

It is possible to dispense fluids, displaying at the same time:

- The dispensed partial.
- The Flow Rate in [Partial Unit / minute] as shown on the following display page:



Procedure for entering this mode:

- Wait for the Remote Display to go to Standby, meaning the display screen shows Total only.
- Quickly press the CAL key.
- Start dispensing.

The flow rate is updated every 0.7 seconds. Consequently, the display could be relatively unstable at lower flow rates. The higher the flow rate, the more stable the displayed value.

- ❑ **IMPORTANT!** The flow rate is measured with reference to the unit of measurement of the Partial. For this reason, in case of the unit of measurement of the Partial and Total being different, as in the example shown below, it should be remembered that the indicated flow rate relates to the unit of measurement of the partial. In the example shown, the flow rate is expressed in Qts/min.

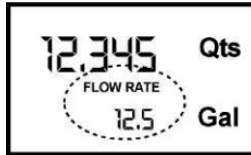

The word "Gal" remaining alongside the flow rate refers to the register of the Totals (Reset or NON Reset) which are again displayed when exiting from the flow rate reading mode.

To return to "Normal" mode, press the CAL key again. If one of the two keys RESET or CAL is accidentally pressed during the count, this will have no effect.

- ❑ **IMPORTANT!** Even though in this mode they are not displayed, both the Reset Total and the General Total (Total) increase. Their value can be checked after dispensing has terminated, returning to "Normal" mode, by quickly pressing CAL.

4.3.1 Partial Reset



To reset the Partial Register, finish dispensing and wait for the Remote Display to show a Flow Rate of 0.0 as indicated in the illustration then quickly press RESET.

5. CALIBRATION

5.1 Definitions

Calibration factor or "k factor" :

Multiplication factor applied by the system to the electrical pulses received, to transform these into measured fluid units.

FACTORY K FACTOR:

Factory-set default factor. It is equal to 1,000. This calibration factor ensures utmost precision in the following operating conditions:

Fluid diesel fuel

Temperature: 20°C

Flow rate: 5-100 ltr/min

Even after any changes have been made by the user, the factory k factor can be restored by means of a simple procedure.

USER K FACTOR:

Customized calibration factor, meaning modified by calibration.

5.2 Why Calibrate

When operating close to extreme conditions, such as for instance with fluids close to acceptable range extremes (like diesel fuel at low temperatures) or in extreme flow rate conditions (close to minimum or maximum acceptable values), an on-site calibration may be required to suit the real conditions in which the ADB02 is required to operate.

5.3 Calibration Procedure:

ADB02 permits making quick and precise electronic calibration by changing the calibration factor (k factor). There are 2 different ways of calibration:

1. On-site calibration, performed by means of a dispensing operation.
2. Direct calibration, performed by directly changing the k factor.

To enter the calibration phases it is necessary to press and hold down the CAL button.

Why enter the calibration phases?

- To display the currently used calibration factor.
- Return to factory k factor after a previous calibration with user k factor.
- Change the calibration factor using one of the two previously indicated procedures.

In calibration mode, the partial and total dispensed quantities indicated on the display screen take on different meanings according to the calibration procedure phase. During the calibration, the ADB02 cannot perform any normal dispensing operations. In calibration mode, the totals are not increased.

- ❑ **WARNING!** The ADB02 features a non-volatile memory. It keeps the calibration and dispensing data stored even after replacing new batteries or long periods of inactivity.

5.3.1 Display Of Current "K Factor" And Restoring "Factory K Factor"

By pressing the CAL key while the appliance is in standby, the display page appears showing the current calibration factor used.



If you are using ADB02 with "factory k factor", the display page shown in the diagram will be displayed, with the word "fact".



If one "user k factor" has been set, the calibration factor set by the user (in our example 0.998) will be displayed. The word "user" indicates a calibration factor set by the user is being used.

The flow chart alongside shows the switchover logic from one display page to another. In this condition, the Reset key permits switching from User factor to Factory factor.

To confirm the choice of calibration factor, quickly press CAL while "User" or "Fact" are displayed. After the restart cycle, the meter uses the calibration factor that has just been confirmed.

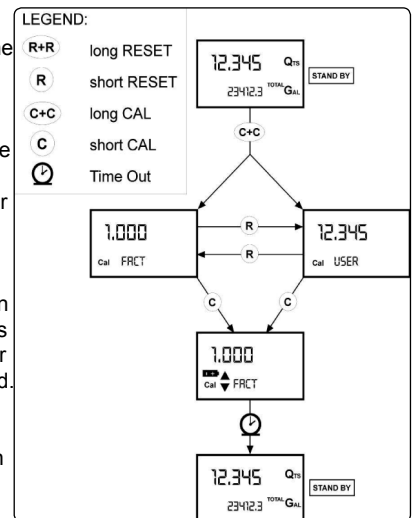

- ❑ **ATTENTION!** When the Factory Factor is confirmed, the old User factor is deleted from the memory.

5.3.2 In-field Calibration

This procedure calls for the fluid to be dispensed into a graduated sample container in real operating conditions (flow rate, viscosity, etc.) requiring maximum precision.

- ❑ **WARNING!** For correct ADB02 calibration, it is important to:
 - Completely eliminate air from the system before calibrating.
 - Use a precise Sample Container with a capacity of not less than 5 litres, featuring an accurate graduated indicator.
 - Ensure calibration dispensing is done at a constant flow rate equivalent to that of normal use, until the container is full.
 - **DO NOT** reduce the flow rate to reach the graduated area of the container during the final dispensing stage (the correct method during the final stages of sample container filling consists in making short topups at normal flow rate).
 - After dispensing, wait a few minutes to make sure any air bubbles are eliminated from the sample container. Only read the Real value at the end of this stage, during which the level in the container could drop.
 - If necessary, carefully follow the procedure indicated in 5.4.

5.4 In-field Calibration Procedure

5.4.1 ADB02 In Stand by Mode

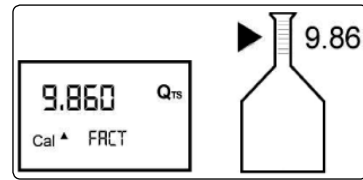

Indicated value Real value

5.4.2 Press the CAL Key for 2 Seconds
ADB02 enters calibration mode, shows "CAL" and displays the calibration factor in use instead of total. The words "FACT" and "USER" indicate which of the two factors is currently in use.



ADB02 calculates the new USER K FACTOR. This calculation could require a few seconds, depending on the correction to be made. During this operation the arrow disappears but the CAL indication remains.

If this operation is performed after operation (5.4.5), without changing the indicated value, the USER K FACTOR would be the same as the FACTORY K FACTOR, thus it is ignored.

5.4.3 Press the RESET Key for 2 Seconds
ADB02 shows "CAL" and the partial at zero. ADB02 is ready to perform on-site calibration.



5.4.9 At the end of the calculation, the new USER K FACTOR is shown for a few seconds, after which the restart cycle is repeated to finally achieve standby condition.



5.4.4 Dispensing into Sample Container
Without pressing any KEY, start dispensing into the sample container.

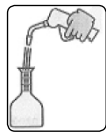

ATTENTION! From now on, the indicated factor will become the calibration factor used by the meter and will continue to remain such even after a battery change.

Dispensing can be interrupted and started again at will. Continue dispensing until the level of the fluid in the sample container has reached the graduated area. There is no need to reach a preset quantity.

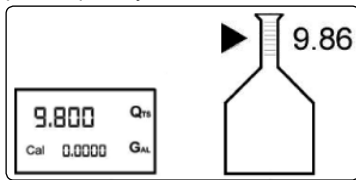

Indicated value Real value

5.4.10 ADB02 stores the new calibration factor and is ready for dispensing, applying the newly defined USER K FACTOR.



5.5 Direct Modification of K Factor

This procedure is especially useful to correct a "mean error" obtainable on the basis of several performed dispensing operations. If normal ADB02 operation shows a mean percentage error, this can be corrected by applying to the currently used calibration factor a correction of the same percentage. In this case, the percentage correction of the USER K FACTOR must be calculated by the operator in the following way:

Example:

Error percentage found E% - 0.9 %

CURRENT calibration factor 1,000

New USER K FACTOR = 1,000 * [(100 - (- 0.9))/100]=

1,000 * [(100 + 0.9)/100] = 1.009

If the meter indicates less than the real dispensed value (negative error) the new calibration factor must be higher than the old one as shown in the example. The opposite applies if the meter shows more than the real dispensed value (positive error).

5.4.5 Press the RESET Key

ADB02 is informed that the calibration dispensing operation is finished. Make sure dispensing is correctly finished before performing this operation.



To calibrate the ADB02, the value indicated by the partial totaliser (example 9.800) must be changed to the real value marked on the graduated sample container. In the bottom left part of the display an arrow appears (upwards and downwards), that shows the direction (increase or decrease) of the USER K FACTOR value change when the operations 5.4.6 or 5.4.7 are performed.

5.5.1 ADB02 in STAND BY Mode



5.4.6 Press the RESET Key

Arrow direction changes. The operation can be repeated if necessary.



5.5.2 Press the CAL Key for 2 Seconds

ADB02 enters calibration mode, shows "CAL" and displays the calibration factor being used instead of the partial. The words "FACT" and "USER" indicate which of the two factors (factory or user) is currently being used.



5.4.7 Press the CAL Key

The indicated value changes in the direction indicated by the arrow by one unit for each press of the CAL key. By continuous holding of the CAL key the first 5 units will change slowly and will then change quickly. If the desired value is exceeded, repeat the operations from point (5.4.6).



5.5.3 Press the RESET Key for 2 Seconds

ADB02 shows "CAL" and the partial at zero. ADB02 is ready to perform on-site calibration by dispensing.

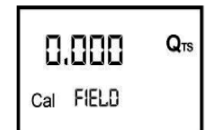

5.4.8 Press the RESET Key for 2 Seconds
ADB02 is informed that the calibration procedure is finished. Before doing this, make sure the DISPLAYED factor is the ACTUAL factor.

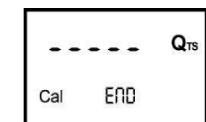

5.5.4 Press the RESET Key for 2 Seconds

We now go on to Direct change of the calibration factor: the word "Direct" appears together with the Currently Used calibration factor. In the bottom left part of the display, an arrow appears (upwards or downwards) defining the direction (increase or decrease) of change of the displayed value when subsequent operations 5.5.5 or 5.5.6 are performed.



5.5.5 Press the RESET Key

Arrow direction changes. The operation can be repeated to alternate the direction of the arrow.



5.5.6 Press the CAL Key

The indicated value changes in the direction indicated by the arrow by one unit for each press of the CAL key. By continuous holding of the CAL key the first 5 units will change slowly and will then change quickly. If the desired value is exceeded, repeat the operations from point (5.4.5).



5.5.7 Press the RESET Key for 2 Seconds

ADB02 is informed that the calibration procedure is finished. Before performing this operation, make sure the indicated value is that required.

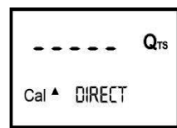

At the end of the calculation, the new USER K FACTOR is shown for a few seconds, after which the restart cycle is repeated to finally achieve standby.



ATTENTION! From now on, the indicated factor will become the calibration factor used by the meter and will continue to remain such even after a battery change.

The ADB02 stores the new work calibration factor and is ready to begin dispensing, using the USER K FACTOR that has just been calculated.



5.6 Unit Configuration

Some models of meter feature a menu with which the user can select the main measurement unit, Quarts (Qts), Pints (Pts), Litres (L), Gallons (Gal). The combination of the unit of measurement of the Partial register and that of the Totals is predefined according to the following table:

Combination No	Unit of Measure of the Partial Register	Unit of Measure of the Totals Register
1	Litres (L)	Litres (L)
2	Gallons (Gal)	Gallons (Gal)
3	Quarts (Qts)	Gallons (Gal)
4	Pints (Pts)	Gallons (Gal)

To choose between the 4 available combinations:

- 5.6.1 Wait for ADB02 to go to Standby.
- 5.6.2 Press the CAL and RESET keys together. Keep these pressed until the word "UNIT" appears on the screen together with the unit of measurement set at that time (in this example Litres / Litres).
- 5.6.3 Press the RESET key to select the desired combination of unit of measurement, amongst those shown below.

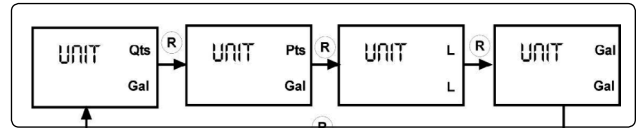

5.6.4 Save the new combination by pressing the CAL key at length. ADB02 will pass through the start cycle and will then be ready to dispense in the set units.

WARNING! The Resettable Total and Total registers will be automatically changed to the new unit of measurement. No

6. MAINTENANCE

new calibration is required after changing the Unit of Measurement. ADB02 has been designed to require a minimum amount of maintenance.

6.1 Battery Replacement

ADB02 is supplied with 2 x 1.5 V. alkaline AAA batteries and features two low-battery alarm levels.

6.1.1 When the battery charge falls below the first level on the LCD, the fixed battery symbol appears. In this condition, ADB02 continues to operate correctly, but the fixed icon warns the user that it is ADVISABLE to change the batteries.



6.1.2 If ADB02 operation continues without changing the batteries, the second battery alarm level will be reached which will prevent operation. In this condition the battery icon starts to flash and is the only one to remain visible on the LCD.

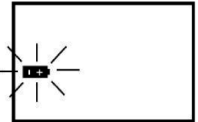

WARNING! Discard the old batteries in accordance with local authority regulations.

6.1.3 Press RESET to update all the totals.

6.1.4 Loosen and remove the 4 fixing screws of the bottom cover (fig.3).



6.1.5 Remove the old batteries (fig.4).

6.1.6 Place the new batteries in the same position as the old ones.



6.1.7 Close the cover again, by positioning the rubber protection as a gasket.

6.1.8 ADB02 will switch on automatically and normal operation can be resumed. The ADB02 will display the same Reset Total, the same Total and the same Partial indicated before the batteries were changed. After changing the batteries, the meter does not need calibrating again.

6.2 Cleaning

Only one operation is necessary to clean the ADB02. Remove the ADB02 from the system and carefully clean any residual elements from the turbine.

Note: If the turbine will not rotate freely, contact your Sealey dealer.

WARNING! DO NOT use compressed air onto the turbine in order to avoid damage due to excessive rotation.

7. TROUBLESHOOTING

Problem	Possible Cause	Remedy
No LCD display	Bad battery connection	Check /Clean Battery terminals
	Batteries expired	Replace batteries
Incorrect measurements	Wrong K Factor	Refer to Section 5 Calibration
	Flow rate below meter limits	Increase flow rate
Reduced or zero flow rate	Turbine blocked	Clean turbine
Meter not recording flow	Faulty PCB	Contact your Sealey dealer
	Faulty turbine	Contact your Sealey dealer

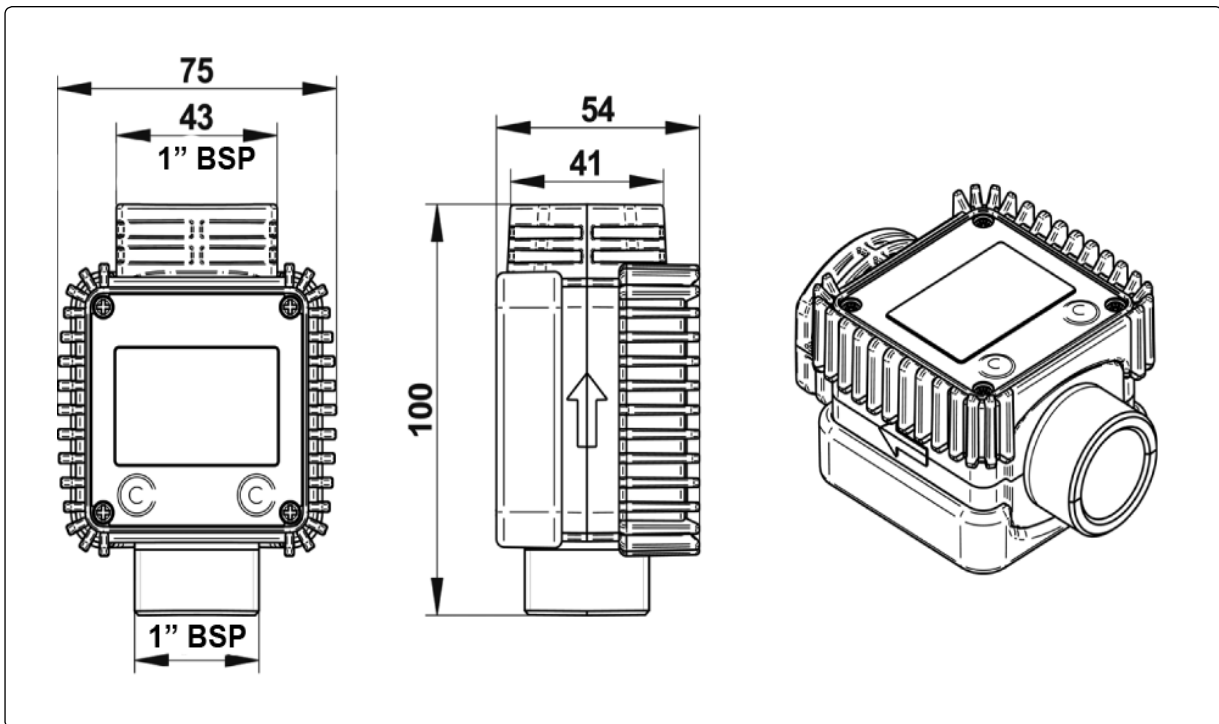

Under the Waste Batteries and Accumulators Regulations 2009, Jack Sealey Ltd are required to inform potential purchasers of products containing batteries (as defined within these regulations), that they are registered with Valpak's registered compliance scheme. Jack Sealey Ltd's Batteries Producer Registration Number (BPRN) is BPRN00705. See section 6.1 for battery removal details



Environmental Protection.

Recycle unwanted materials instead of disposing of them as waste. All tools, accessories and packaging should be sorted, taken to a recycle centre and disposed of in a manner which is compatible with the environment.

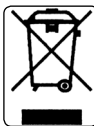

WEEE Regulations.

Dispose of this product at the end of its working life in compliance with the EU Directive on Waste Electrical and Electronic Equipment. When the product is no longer required, it must be disposed of in an environmentally protective way. Contact your local solid waste authority for recycling information.

NOTE: It is our policy to continually improve products and as such we reserve the right to alter data, specifications and component parts without prior notice.

IMPORTANT: No liability is accepted for incorrect use of product.

WARRANTY: Guarantee is 12 months from purchase date, proof of which will be required for any claim.

INFORMATION: Call us for a copy of our latest catalogue on 01284 757525 and leave your full name and address including your postcode.



Sole UK Distributor, Sealey Group,
Kempson Way, Suffolk Business Park,
Bury St. Edmunds, Suffolk,
IP32 7AR

01284 757500

www.sealey.co.uk

01284 703534

sales@sealey.co.uk